

Gallotti&Radice



Lui

2010

Desk with 12mm transparent or extralight tempered glass top with bright or satin stainless steel structure. Also available 12mm smoked "grigio Italia" tempered glass top with burnished lacquered metal structure. Natural ash, wengé stained, tobacco stained, lacquered white or lacquered black open pore bottom shelf and drawers. On request suede pad, available colours as per sample.

Cm (L x W x H)

140 x 65 x 75

160 x 65 x 75

180 x 65 x 75

Tappetino in pelle scamosciata / Suede pad

53.8 x 61.8

73.8 x 61.8

93.8 x 61.8

Inches (L x W x H)

55¼ x 25¾ x 29¾

63 x 25¾ x 29¾

71 x 25¾ x 29¾

Tappetino in pelle scamosciata / Suede pad

21¼ x 24½

29¼ x 24½

37 x 24½

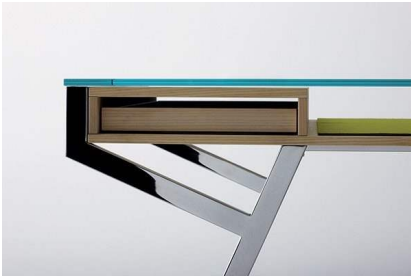
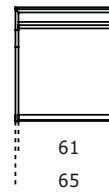
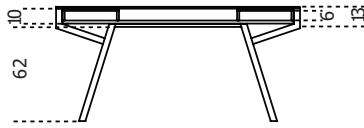
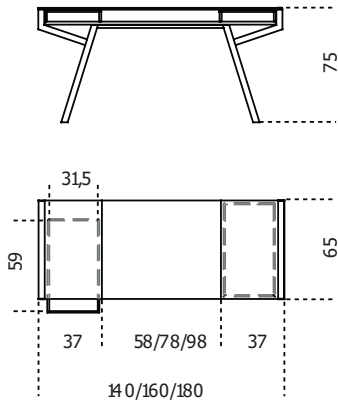

Finishings

Glass



"Grigio Italia"

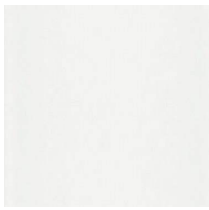

Extralight

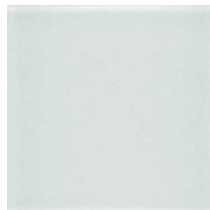

Transparent

Metal

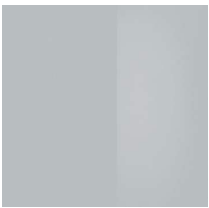

Bright stainless
steel



Burnished
lacquered metal

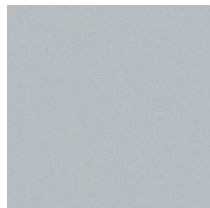

Satin stainless
steel

Wood



Black open pore
lacquered ash



Natural ash



Tobacco stained
ash

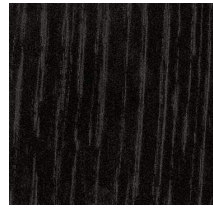

Wengè stained
ash



White open pore
lacquered ash

Leather Cat.L1



Suede grey 020

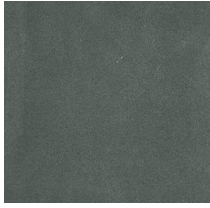

Suede grey 058

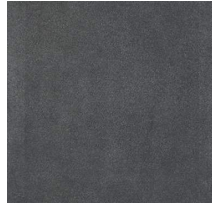

Suede grey 074

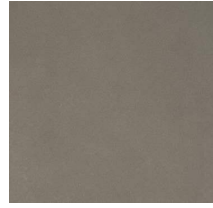

Suede sand 006



Suede sand 012