

# Lui

Paolo Maria Fumagalli  
2010



Desk with 12mm transparent or extralight tempered glass top with bright or satin stainless steel structure. Also available 12mm smoked "grigio Italia" tempered glass top with burnished lacquered metal structure.

Natural ash, wengé stained, tobacco stained, lacquered white or lacquered black open pore bottom shelf and drawers.  
On request suede pad, available colours as per sample.

## Cm (L x P x H)

140 x 65 x 75

160 x 65 x 75

180 x 65 x 75

53.8 x 61.8 x 0

73.8 x 61.8 x 0

93.8 x 61.8 x 0

## Inches (L x P x H)

55¼ x 25¾ x 29¾

63 x 25¾ x 29¾

71 x 25¾ x 29¾

21¼ x 24½ x 0

29¾ x 24½ x 0

37 x 24½ x 0

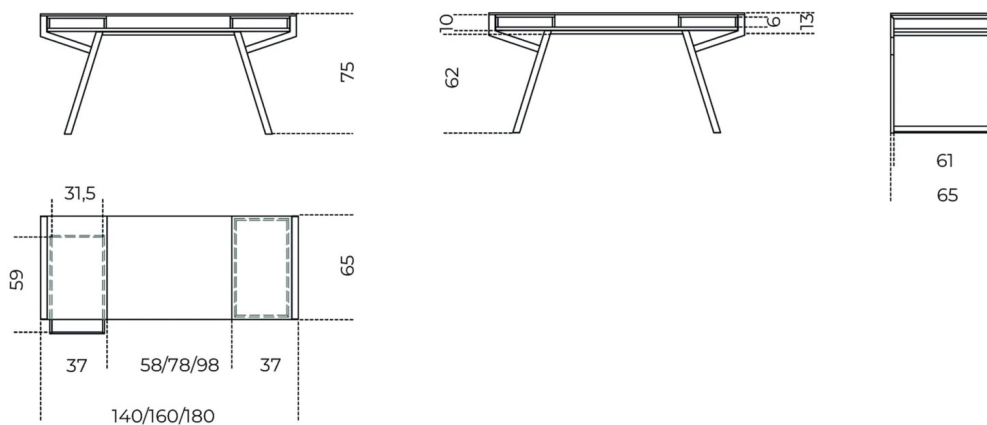

# Finishes

## Glass



Extralight



"Grigio Italia"

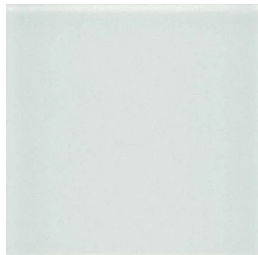

Transparent

## Wood

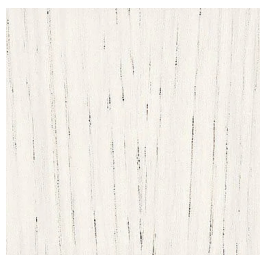

White open pore  
lacquered ash

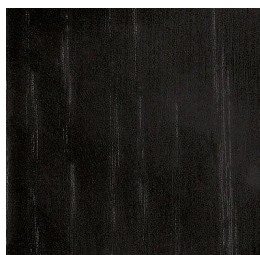

Black open pore  
lacquered ash

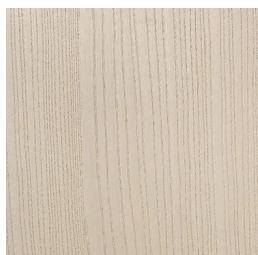

Natural ash

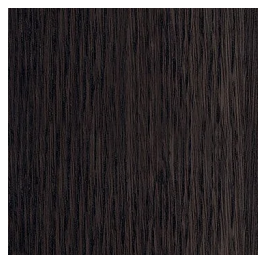

Tobacco stained ash

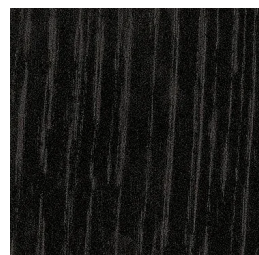

Wengè stained ash

## Metal



Bright stainless steel

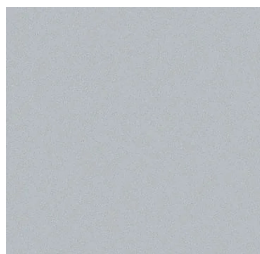

Satin stainless steel



Burnished lacquered

## Leather Cat.L1

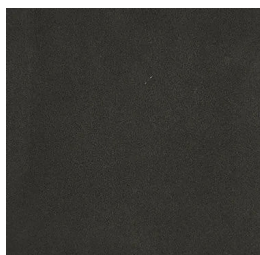

Suede grey 020

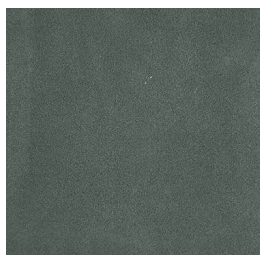

Suede grey 058

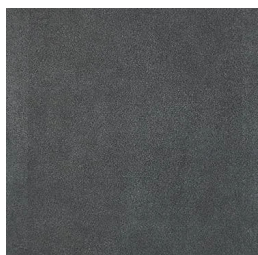

Suede grey 074

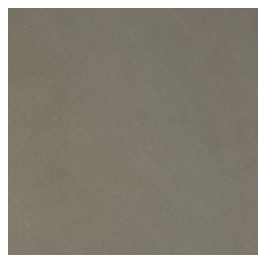

Suede sand 006

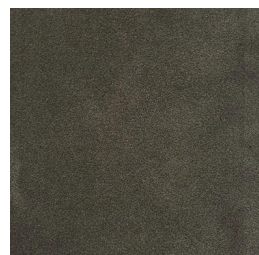

Suede sand 012