

Milano

Daniele Moschieri Lo Scalzo
2011

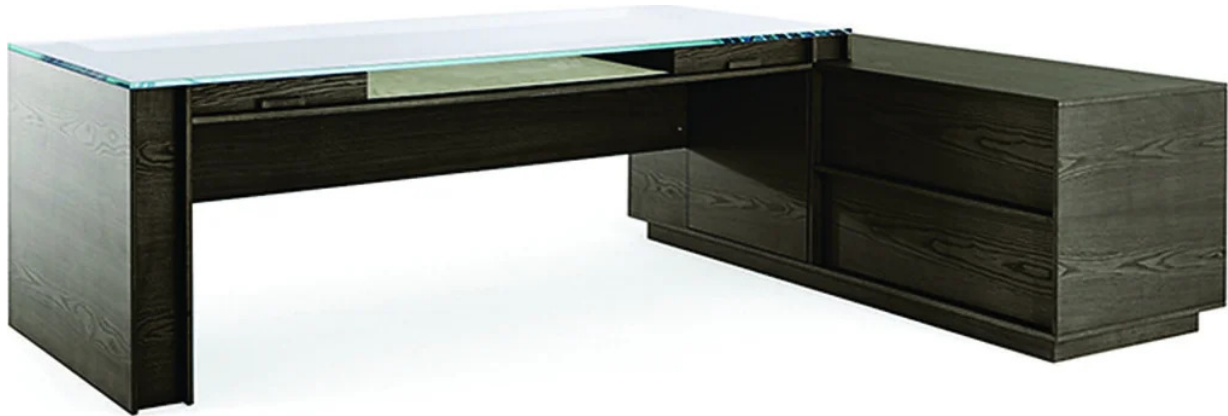

Executive desk with structure and drawers in natural ash, tobacco stained or black open pore lacquered ash. 15mm transparent or extralight glass top. Also available with 12mm smoked "grigio Italia" tempered glass top. Suede writing pad as per samples.

Cm (L x P x H)

182 x 90 x 75

232 x 90 x 75

50 x 0 x 57

100 x 0 x 57

Inches (L x P x H)

71³/₄ x 35¹/₂ x 29³/₄

91¹/₂ x 35¹/₂ x 29³/₄

19³/₄ x 0 x 22¹/₂

39¹/₂ x 0 x 22¹/₂

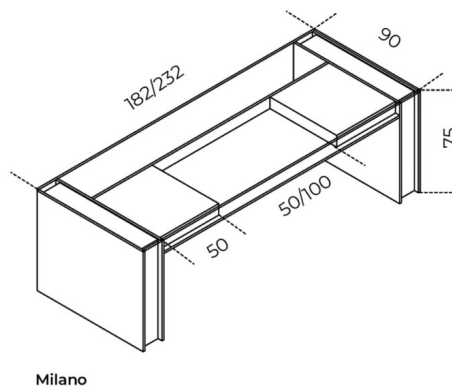
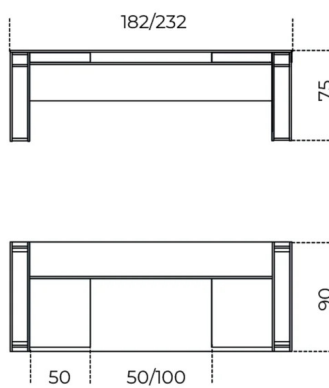

Finishes

Glass



Extralight



"Grigio Italia"

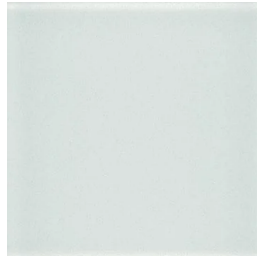

Transparent

Wood



Black open pore
lacquered ash



Natural ash



Tobacco stained ash

Leather Cat.L1

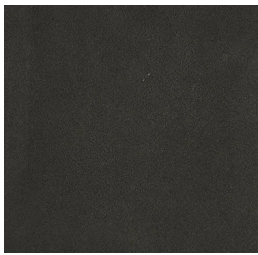

Suede grey 020

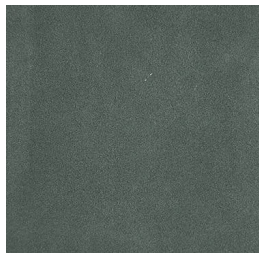

Suede grey 058

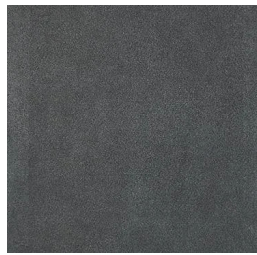

Suede grey 074



Suede sand 006

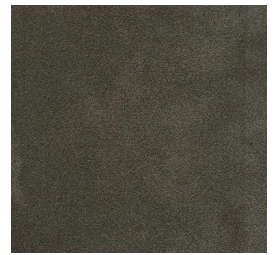

Suede sand 012